

ZANUSSI

WASHER-DRYER WD 15

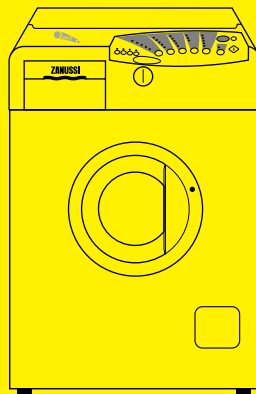



Important Safety Information

It is important that this instruction book be kept with the appliance for future reference. If you sell or give the appliance away, make sure that the book is passed to the new owners so that they can familiarise themselves with its operation and relevant warnings.

The following warnings are provided in the interests of overall safety. You must read them carefully before installing or using the appliance.

Installation

- This appliance is heavy. Care should be taken when moving it.
- It is dangerous to alter the specifications or attempt to modify this product in any way.
- All packing and transit bolts must be removed before use. Serious damage can occur to the product and to property if this is not adhered to. See relevant section in instructions.
- Any plumbing work required to install this appliance should be carried out by a qualified plumber or competent person.
- Any electrical work required to install this appliance should be carried out by a qualified electrician or competent person.
- Care must be taken to ensure that the appliance does not stand on the electrical supply cable.
- If the machine is situated on a carpeted floor, please adjust the feet in order to allow air to circulate freely.

Child Safety

- This appliance is designed to be operated by adults. Children should not be allowed to tamper with the controls or play with the product.
- Pets and children have been known to climb into washer-dryers. Please check your drum before use.
- The glass door becomes very hot during the washing and drying cycle. Keep children away from the vicinity of the appliance whilst it is in operation.
- Keep all packaging well away from children.
- Keep all detergents in a safe place out of children's reach.

Use

- Always unplug the appliance and turn off the water supply after use.
- Do not overload the appliance. See relevant section in the instruction book.
- Only wash and dry fabrics which are designed to be machine washed and dried. If in doubt, consult the care label on the clothes.

- Before washing, ensure that all pockets are empty and buttons and zips are fastened. Avoid washing frayed or torn articles and treat stains such as paint, ink, rust, and grass before washing. Underwired bras must NOT be machine washed.
- Any objects such as coins, safety pins, nails, screws, stones or any other hard, sharp material can cause extensive damage and must not be placed into the machine.
- Garments which have been in contact with volatile petroleum products should not be machine washed. If volatile cleaning fluids are used, care should be taken to ensure that the fluid is removed from the garment before placing in the machine.
- Wash small items such as socks, laces, washable belts etc in a washing bag or pillow case as it is possible for such items to slip down between the tub and the inner drum.
- Only use the advised quantities of fabric softener. Damage to the fabric can ensue if you over-fill. Refer to the manufacturer's recommendations of quantities.
- As some duvets and eiderdowns should be washed/dried in large commercial machines because of their bulk, please check with the manufacturer of the item before washing in a domestic machine.
- The users should always check that they have not left their gas lighters (disposable or otherwise) in their clothing.
- Never tumble dry items that have had contact with chemicals such as dry cleaning fluid. These are of a volatile nature and could cause an explosion. Only tumble dry items which have been washed in water or require airing.
- Plastic detergent dispensers should not remain in the drum during the drying cycle, as the plastic used is not designed to withstand the heat. If you wish to wash-through-to-dry you should use the conventional detergent dispenser drawer.
- Leave the porthole door slightly ajar between washes to preserve the door seal.
- Under no circumstances should you attempt to repair the machine yourself. Repairs carried out by inexperienced persons may cause injury or serious malfunctioning. Contact your local Zanussi Service Force Centre. Always insist on genuine Zanussi spare parts.

Contents

For the User

Important Safety Information	2
Your New Washer-Dryer	4
Description of the Appliance	5
Door locked indicator light	5
Detergent dispenser drawer	5
The Control Panel	6-9
Altering a programme which is running	9
Opening the door after the wash programme...	9
Programme selection Washing	10
Operating sequence	11-13
Load the laundry	11
Measure out the detergent	11
Add the fabric softener, if required	11
Switch the machine on	11
Select the required programme	12
Select the temperature	12
Select spin speed or Rinse Hold option	12
Select the PREWASH, QUICK WASH or ECONOMY option, if required	12
Select the DELAY START option, if required	12
Start the programme	13
Store the programme	13
At the end of the programme	13
Programme selection	14
Drying	14
Operating sequence	15
Load the laundry	15
Switch the machine on	15
Select drying	15
Start the programme	15
At the end of programme	15
Washing and Drying Hints	16
Which detergent?	17
And in which form?	17

Preparing the drying cycle	18
Garments not suitable for drying	18
Drying symbols on garment labels	18
Duration of the drying cycle	18
Additional drying	18
Fibre residue	18
Wash Care Symbols	19
Washing Programmes	20
Special Programmes	21
Drying Programmes	22
Maintenance and Cleaning	23-24
Descaling	23
After each wash	23
External cleaning	23
Cleaning the dispenser drawer	23
Cleaning the drawer recess	23
Cleaning the filter	24
The danger of freezing	24
Something Not Working	25-26
Service & Spare Parts	26
Customer Care	26
Standard guarantee conditions	27

For the Installer

Installation Instructions	28
Technical Specifications	28
Unpacking	29
Positioning	29
Water inlet	30
Water drainage	30
Levelling	31
Special conditions	31
In the interest of the environment	31
Electrical connection	32
Permanet connection	32

Guide to use the Instruction Book

The following symbols will be found in the text to guide you throughout the instructions:



Safety instructions



Hints and tips



Environmental information

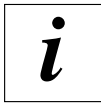

Your New Washer-Dryer

Your new washer-dryer, fitted with the Zanussi “JET SYSTEM”, meets all modern needs for effective treatment of laundry with low water, energy and detergent consumption.

Even small loads are washed “economically” because the amount of water used is regulated automatically according to the load and type of fabric.

- **The “Memory” buttons** enable you to store the wash programmes most used, which are then easy to recall when needed.
- **The possibility** of selecting the temperature, spin speed and all the options offered by this machine gives you truly “customised” washing.
- **The DELAY START** option allows you to delay starting of the wash or drying programme.
- **Fuzzy Logic technology** enables the washing time in the White cotton and Coloured cotton programmes to be calculated automatically according to the weight of the laundry.
- **Automatic cooling of the wash water to 60°C** before draining, with the 95°C programme. This reduces thermal shock to fabrics, helping to prevent creasing.
- **The special wool programme** with its new delicate wash system treats your woollens with extreme care.
- **The Handwash programme** has an extremely delicate wash action suitable for garments with the wash symbol .
- **The drying programmes** will enable you to have dry and soft laundry in a short time.

Important

Your machine is fitted with a balance control device, which ensures the machine is stable during the spin. If the wash load appears not to have been spun sufficiently at the end of the wash cycle, because it is not evenly distributed in the drum, the balance control device may have operated. It will therefore be necessary to redistribute the wash load manually and select a spin programme. For more detailed information see the section headed "Something Not Working".



Ecological hints

To save water and energy and help protect the environment, we recommend that you follow these hints:

- Adjust the quantity of detergent according to the hardness of your water supply, the amount of laundry and the degree of soiling.
- Select an “economy” programme for normally soiled laundry and a “quick” programme for lightly soiled laundry.
- A programme without prewash is sufficient for normally soiled laundry.



In the interest of the environment

- Materials marked with the symbol  are recyclable.
- Check with your local Council or Environmental Health Office to see if there are facilities in your area for re-cycling this appliance.
- When the appliance is to be scrapped, cut off the power supply cable and make the door closing device unusable to prevent young children from being trapped inside.
- Help to keep your country tidy - use authorised disposal sites for your old appliance.

**How do we help to protect the environment?
We use recycled paper!**

Description of the Appliance

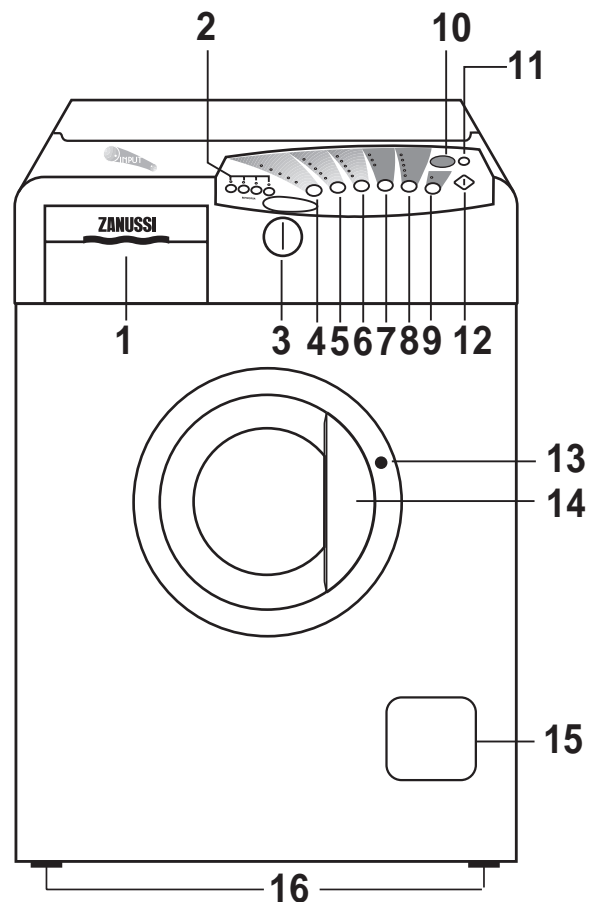

- 1 Detergent dispenser drawer
- 2 “Memory” buttons
- 3 “ON/OFF-Cancel” button
- 4 “Fabrics” button
- 5 “Temperature” button
- 6 “Spin speed” button
- 7 “Options”/Special Programmes button
- 8 “Auto dry” button
- 9 “Drying time” button
- 10 “Time to finish” display
- 11 “Delay start” button
- 12 “START/PAUSE” button
- 13 “Door locked” indicator light
- 14 Door opening handle
- 15 Filter
- 16 Adjustable feet



Door locked indicator light

The door stays locked throughout the wash and drying cycle, which is indicated by a light located next to the door handle. The door cannot be opened until the light has gone out.

Detergent dispenser drawer

-  Prewash
-  Main wash
-  Fabric softener

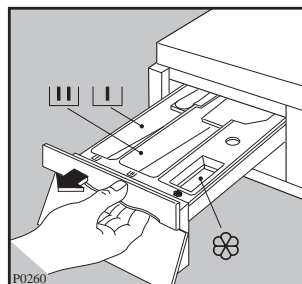

The Control Panel

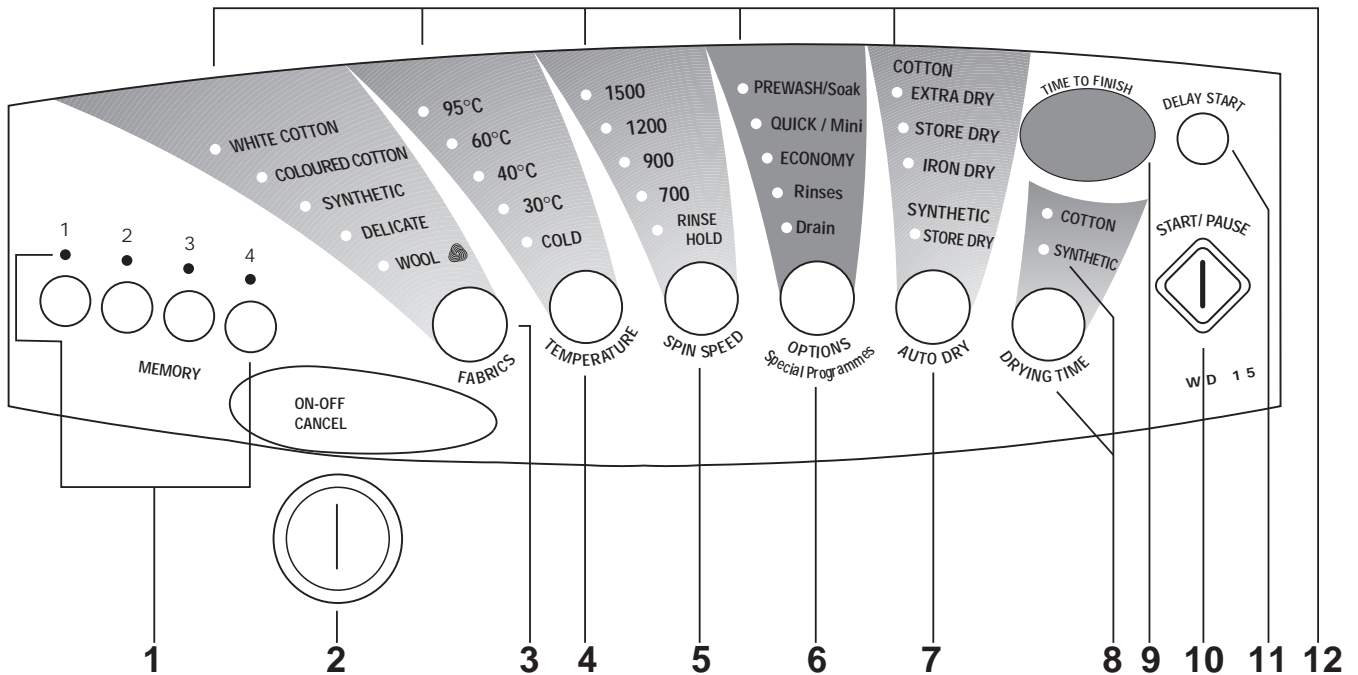

1 "Memory" buttons and corresponding pilot lights

A washing and/or drying programme can be stored or recalled by pressing these buttons.

To store: select the required programme using the various buttons available (see section "Operating sequence"), then start the machine by pressing the START/PAUSE button. Only then can the programme be stored by pressing one of the "Memory" buttons until the corresponding pilot light comes on.

If the "Memory" button pressed does not yet have a programme stored, the pilot light flashes for two seconds.

A stored programme can be modified by pressing the required buttons before starting the machine with the START/PAUSE button.

To recall a programme: press the required "Memory" button; the pilot lights corresponding to the stored programme come on. Press the START/PAUSE button to start the machine.

Warning! A programme may have been stored during testing in the factory.

Note: It is advisable to make a note of the programme stored for each "Memory" button.

2 ON/OFF-Cancel button

This button has two functions:

- switch the machine on/off
- cancel a programme which is running

Press the button to switch the machine on, press it again to switch the machine off or **to cancel** a programme which is running.

3 "Fabrics" button

Press this button to select the type of wash required: White cotton, Synthetic, etc. The pilot light corresponding to the type of wash selected comes on and the washing time flashes on the display (9); time is calculated on the basis of a maximum load of 5 kg for cotton, 2 kg for delicate and synthetics and 1 kg for wool.

The machine automatically selects the maximum temperature and spin speed based on the type of wash selected: the corresponding pilot lights come on.

These values can be decreased by pressing the TEMPERATURE and SPIN SPEED buttons.

The "Fabrics" button cannot be used when the following programmes are selected:

- Soak
- Mini
- Rinses
- Drain
- Spin

4 "TEMPERATURE" button

Press this button if you wish to set a different temperature from that suggested by the machine for the type of wash selected (see programme chart): the corresponding pilot light comes on.

The COLD position is for a wash with cold water.

5 SPIN SPEED button

This button has two functions:

- selection of the spin speed or of the Rinse Hold option;
- separate spin programme.

SELECTION OF THE SPIN SPEED:

- for cottons (White cotton, Coloured cotton) the maximum spin speed is 1500 rpm;
- for synthetics and wool the maximum spin speed is 900 rpm;
- for delicate fabrics the maximum spin speed is 700 rpm.

SELECTION OF THE RINSE HOLD OPTION

When this option is selected, the last rinse water is not drained, to prevent creasing of the fabrics: the corresponding pilot light flashes at the end of the programme to indicate that the water must be emptied out.

This can be done in three ways:

- select a spin speed and press the START/PAUSE button
- just press the START/PAUSE button; after emptying, the machine performs the spin cycle for the type of wash selected
- select the DRAIN programme to empty out the water without spinning.

The RINSE HOLD option can also be selected for the wool programme: the last rinse water is drained but the machine does not spin.

The machine automatically drains after 18 hours, if a drain or spin programme is not selected.

SEPARATE SPIN PROGRAMME

To be used to spin hand washed laundry:

- switch the machine on by depressing the ON-OFF button
- select the desired spin speed
- depress START/PAUSE button.

6 "OPTIONS" (Special Programmes) button

By depressing this button you can select two different functions:

- additional options for the selected washing programme
- separate special programmes.

Important!

The first and second light indicate:

- Prewash or Soak
- Quick or Mini.

Additional options

After selecting the wash programme you can add one of the following functions:

- **PREWASH:** the machine performs a prewash cycle at 40°C max. The prewash cycle ends with a short spin for the White cotton, Coloured cotton and Synthetic programmes, and with emptying of the water for the Delicate programme. This option is **not** available with the wool programme.
- **QUICK WASH:** by selecting this option the washing time is reduced. For use when washing lightly soiled laundry. If you use this option with the wool programme you will obtain an extremely delicate wash action suitable for garments with the wash symbol .
- **ECONOMY:** This option is only available with the following programmes. The temperature is reduced as shown.

Programme	Temperature reduced to
White Cotton 95°C	67°C
Coloured Cotton 60°C	45°C
Synthetic 60°C	40°C

The corresponding temperature light will come on and the wash time will be slightly longer to compensate for the temperature reduction.

Important: the PREWASH, QUICK WASH and ECONOMY options **cannot** be selected together: one automatically disables the others.

SEPARATE SPECIAL PROGRAMMES

Important! When selecting these programmes the “FABRICS” button **must not** be depressed.

- switch the machine on
- select the desired special programme
- depress START/PAUSE button to start the programme.
- **SOAK:** for heavily soiled laundry, **not for wool.** The machine performs a soak at 40°C (the drum rotates occasionally) and stops with the water in the drum. The water can be emptied out in 2 ways:
 - **empty only** by pressing the START/PAUSE button;
 - **empty and spin** selecting a SPIN SPEED and pressing START/PAUSE button.

The machine automatically drains after 18 hours, if a drain or spin option has not been selected.

At the end of the soak, and after having emptied out the water (the three zeros on the display flash), select the required wash programme (the machine must be first switched off and then on) or call one up using the “memory” buttons, then start the machine by pressing the START/PAUSE button.

- **MINI-WORN ONCE:** this is a complete programme in its own right, that is not compatible with any of the other options, except DELAY START. For use with laundry which is lightly soiled or which needs freshening up (max. 2 kg). The machine performs a 30 minute wash cycle at 30°C, with a final spin at 650 rpm.
- **RINSES:** with this programme, it is possible to rinse and spin garments which have been washed by hand, such as synthetics or delicates and types of wool which are not machine washable. The machine performs 3 delicate rinses with a high water level, followed by a final spin at 700 rpm. To select a slower or a higher spin speed use the SPIN SPEED button.

Important: If you select a spin speed of 1500 or 1200 rpm, the machine will perform 3 rinses with a low water level, a number of intermediate spins and a final spin at 1500 or 1200 rpm; particularly recommended for cottons.

If you select a spin speed of 900 rpm, the machine will perform 3 rinses at high water level.
- **DRAIN:** this programme can be selected to empty out the water (e.g. for programmes with which the **RINSE HOLD** option has been selected).

7 AUTO DRY button

By depressing this button you can selected the following drying programmes:

- **Cotton**
 - Extra dry
 - Store dry
 - Iron dry
- **Synthetics**
 - Store dry

8 DRYING TIME button

By depressing this button you can select the desired drying time according to the fabrics (cotton or synthetics) you have to dry.

- If you select **COTTON**, the appliance will dry at full heating power.
- If you choose **SYNTHETICS** drying will be performed at a reduced heating power.

If you select **SYNTHETICS** and then you wish to change into **COTTON**, depress the **AUTO DRY** button for about 2 seconds until the cotton light turns on.

To select the drying time you have to push the button until the drying time you want appears in the display.

For **COTTON** you can select a drying time from 15 minutes to 2 hours and 10 minutes (2.10).

For **SYNTHETICS** you can select a time from 10 minutes to 1 hours and 40 minutes (1.40).

9 TIME TO FINISH display

This display provides the following information:

- **Three flashing dashes** appear immediately after pressing the ON/OFF button and indicate that the machine is ready to receive instructions for the required programme.
- **Duration of the selected wash programme,** calculated automatically on the basis of the maximum recommended load for each type of fabric. The figures on the display flash until the machine is started with the START button.

After the programme has started, the time remaining is updated every 10 minutes, and every 5 minutes during the last 20 minutes.

About 20 minutes after the programme has started, the time remaining is updated on the basis of the actual load size being washed (cottons only).When the programme has finished, after the door lock has released, three flashing zeros are displayed.

- **Delayed start**, programmed using the DELAY START button (11).

The selected delay (19 hours max.) is indicated in the display. The countdown is updated every hour, and every 5 minutes during the last hour.

- **PAUSE:** when the START/PAUSE is pressed while a wash programme is running, the **figures in the display**, which indicate the time remaining, **start to flash**.
- **Machine heating phase.** A dot to the right of the figures in the display indicates that the machine is heating the water.
- **Incorrect option selection.** If an option which is not compatible with the set wash programme is selected, the message **Err** is displayed.
- **Alarm codes.** In the event of operating problems, a specific code appears in the display (see “Something not working”).

10 START/PAUSE button

This button has three functions:

a) Start

After having selected the required programme, press this button to start the machine; the display stops flashing.

b) Pause

To interrupt a **wash programme** which is running, press the START/PAUSE button: the figures displayed will start to flash.

The drying programmes cannot be interrupted.

To restart the programme from the point at which it was interrupted, **press the START/PAUSE button again.**

c) Drain

At the end of a programme which stops with water in the drum (RINSE HOLD option), or after the soak programme, press the START/PAUSE button to empty out the water: after a soak programme, the machine will empty only; after RINSE HOLD programmes, the machine will empty and spin.

11 DELAY START button

This button allows starting of the machine to be delayed by a maximum of 19 hours.

The button must be pressed after selecting the programme and before pressing the START/PAUSE button.

The figures indicating the time delay appear in the display next to the button. After one minute, the machine starts its countdown (hourly).

During the last hour, the remaining time is displayed every 5 minutes.

The delay start function **cannot** be used with the SPIN and DRAIN programmes.

To alter or cancel the time delay, press the START/PAUSE button, then press the DELAY START button until the required time is displayed or the symbol 0h, if you wish to cancel the delay.

Then press the START/PAUSE button again.

When the delay is cancelled, the display shows the duration of the wash programme previously selected.

12 Operating pilot lights

The pilot lights come on individually, or in groups, according to the options selected.

The pilot lights flash for about three seconds if wash options are incorrectly selected. The message **Err** is displayed.

Altering a programme which is running

To alter a programme, press the START/PAUSE button. Before the machine starts the heating phase, i.e. within the first 15 minutes for cotton programmes, 10 minutes for synthetic and delicate programmes and 5 minutes for the wool programme, the following parameters can be altered:

- Fabrics
- Temperature
- ECONOMY or QUICK WASH.

The PREWASH option can be cancelled, but cannot be added, once the programme has started.

The SPIN SPEED option can be modified before the final spin.

To restart the wash programme, press the START/PAUSE button again.

Opening the door after the wash programme has started

The door can only be opened before the machine starts the heating phase (within the first 15, 10 or 5 minutes, depending on the programme selected - see paragraph above).

Set the machine to PAUSE (by pressing the START/PAUSE button).

If the door does not open, this means that the machine is already heating, or that the water level is above the bottom edge of the door.

This prevents water from spilling out when the door is opened.

The door can only be opened when the pilot light next to the handle goes out.

Programme selection

Washing

There are 3 possibilities for choosing the wash programme:

- Selection by means of the different push-buttons
- Selection using the MEMORY buttons
- Selection of the special programmes.

■ Selection by means of the different push-buttons

1. Depress ON/OFF button to switch the machine on.
2. Depress FABRICS button to select the type of fabric.
3. Depress the TEMPERATURE button if you wish to choose a different temperature from that proposed by the appliance.
4. Depress the SPIN SPEED button if you wish to change the spin speed proposed by the machine.
5. Select an option, if required (PREWASH, QUICK or ECONOMY).
6. Select delayed start, if required.
7. Start the appliance by depressing the START/PAUSE button.

■ Selection using the MEMORY buttons

1. Depress ON/OFF button to switch the machine on.
2. Depress one of the MEMORY buttons.
3. Depress DELAY START button if required.
4. Press the START/PAUSE button to start the appliance.

■ Selection of the special programmes

IMPORTANT!

To select the SPECIAL PROGRAMMES the FABRICS button must not be depressed.

1. Switch the machine on by depressing the ON/OFF button.
2. Select the desired programme (SOAK, MINI, RINSES or DRAIN) by depressing the SPECIAL PROGRAMMES button.
The spin programme can be selected by means of the SPIN SPEED button.
3. Depress START/PAUSE button.

Operating Sequence

WASHING

Before your first wash, we recommend that you run a cotton cycle at 60°C, without any laundry in the machine, to remove any manufacturing residue from the drum and tub.

Pour 1/2 a measure of detergent into the dispenser drawer and start the machine.

1. Load the laundry

Open the door.

Place the laundry in the drum, one item at a time, shaking them out as much as possible. Close the door.

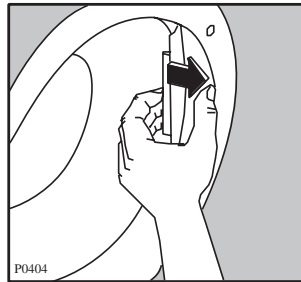

2. Measure out the detergent

Pull out the dispenser drawer until it stops.

Measure out the amount of detergent recommended by the manufacturer in a graduated cup and pour it into the main wash compartment [1].

If you wish to carry out the prewash or soak programme, pour detergent into the compartment marked [2].

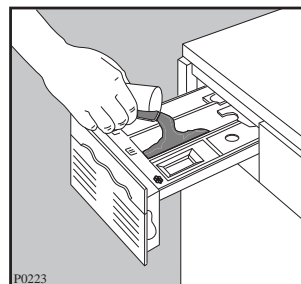

3. Add the fabric softener, if required

If required, pour fabric softener into the compartment marked [3] (the amount used must not exceed the «MAX» mark in the drawer).

Push the detergent drawer back in.

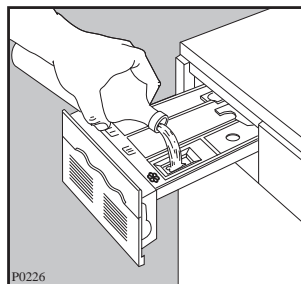

4. Switch the machine on

Press the ON/OFF button to switch the machine on; three flashing dashes are displayed.

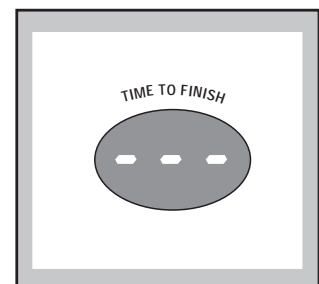
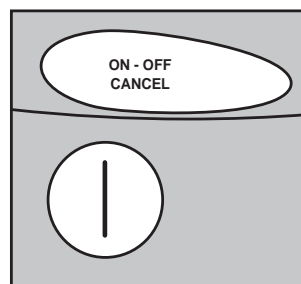

5. Select the required programme

Press the FABRICS button to select the required programme; the corresponding pilot light comes on.

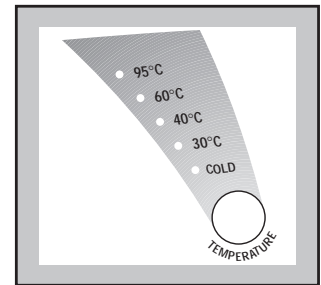
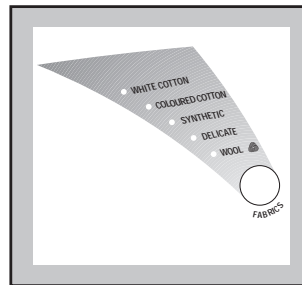

6. Select the temperature

Press the TEMPERATURE button to select the required temperature; the corresponding pilot light comes on.

7. Select spin speed or Rinse Hold option

Press the SPIN SPEED button to select the spin speed or the RINSE HOLD option; the corresponding pilot light comes on.

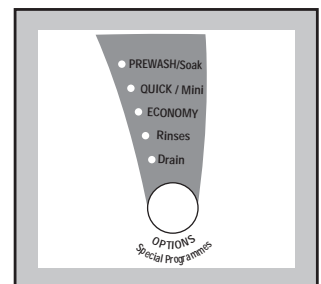
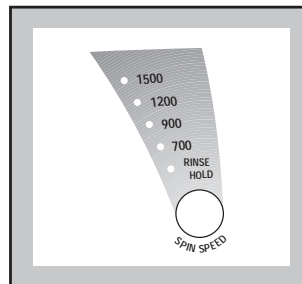

8. Select the PREWASH or QUICK WASH or ECONOMY option, if required,

according to the degree of soil or type of fabric.

The corresponding pilot light comes on.

9. Select the DELAY START option, if required

Before starting the programme, if you wish to delay the start, press the DELAY START button to set the required delay, which appears in the display.

Then press the START/PAUSE button: the machine starts its countdown.

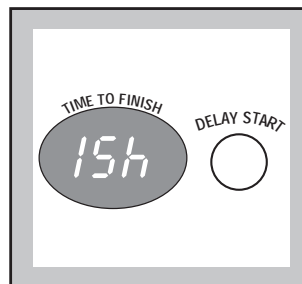

10. Start the programme

To start the selected programme, press the START/PAUSE button; the display stops flashing and the door pilot light comes on to indicate that the door locking device is engaged.

The programme starts after about 30 seconds.

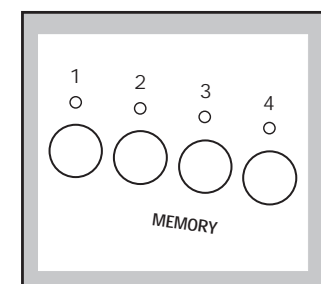
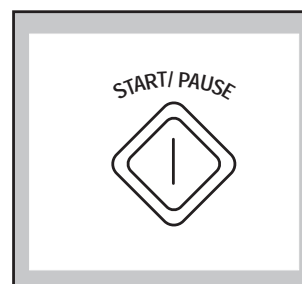

11. Store the programme

The wash programme selected can now be stored by pressing one of the MEMORY buttons until the corresponding pilot light comes on.

12. At the end of the programme

The machine stops automatically and three flashing zeros are displayed.

The programme which has just been completed is still in the memory and the corresponding pilot lights stay on.

If the RINSE HOLD option has been selected, the corresponding pilot light flashes to indicate that the water must be emptied out before opening the door.

The machine is fitted with a safety device that prevents opening of the door for about 2-3 minutes after the end of the programme. The door can only be opened after the door locked indicator light has gone out.

Release of the lock is indicated by an audible signal as well as the pilot light going out.

Switch the machine off by pressing the ON/OFF button.

Remove the laundry from the drum and carefully check that the drum is empty, to avoid any forgotten items being damaged in a subsequent wash e.g. shrinking or colour running.

If you do not intend to carry out another wash, close the water tap.

Leave the door open to prevent the formation of mildew and unpleasant smells.

Programme selection

Drying

There are 3 possibilities for carrying out the drying programme:

- **Automatic washing and drying** (NON-STOP operation)
- **Washing and subsequent drying**
- **Drying only**

■ **Automatic washing and drying**

Max load: cotton 2.5 kg
synthetics 2 kg

1. Switch the machine on by depressing ON/OFF button.
2. Depress FABRICS button to select the required programme.
3. Select the temperature.
4. If possible, do not select a spin speed lower than that proposed by the appliance to avoid a too long drying time so saving energy.
5. Select the required options using the OPTIONS button.
6. Select the desired drying programme or time by means of the AUTO DRY or DRYING TIME button.
7. Start the appliance by depressing START/PAUSE button.

 Do not use a dosing device/ball if using the automatic washing & drying programme.

■ **Washing and subsequent drying**

Washing

Max load: cotton 5 kg
synthetics 2 kg

1. Switch the machine on.
2. Depress FABRICS button to select the desired washing programme.
3. Select the temperature.
4. Select the spin speed or the RINSE HOLD option.
5. Select the required option.
6. Depress the START/PAUSE button.

IMPORTANT!

If you have selected the RINSE HOLD option the last rinse water must be emptied and the laundry must be spun before opening the door and before drying.

■ **Drying**

Max load: cotton 2.5 kg
synthetics 2 kg

The cotton load has to be dried in two steps.

For the synthetics, you can dry the complete load, unless you wish to remove some items that do not need to be dried.

1. Depress the ON/OFF button to switch the machine off thus cancelling the previously selected washing programme.
2. Switch the machine ON by depressing ON/OFF button again.
3. Select the desired drying programme or time.
4. Start the appliance.



WARNING

If you use a dosing device in your washer-dryer, ensure the dosing device/ball is removed before carrying out a drying programme.

Operating sequence

Drying only

If you wish to carry out only a drying cycle, for example to dry hand washed items, you can choose between automatic drying or time controlled drying. In both cases you have to keep the following maximum loads:

- cotton 2.5 kg
- synthetics 2 kg

1. Load the laundry

2. Switch the machine on

Press the ON/OFF button to switch the machine on.

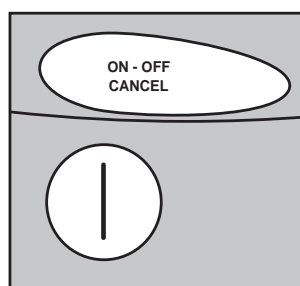

3. Select drying

Depress the AUTO DRY button to choose the required degree of final drying if you wish to dry automatically.

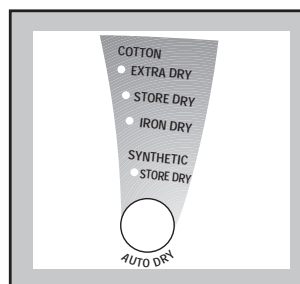

If you want to perform a time controlled drying, depress the DRYING TIME button to select first the type of fabrics (cotton or synthetic) and then continue to depress until the time you want appears in the display: from 15 mins to 2 hours and 10 mins for cotton, from 10 mins to 1 hour and 40 mins for synthetics.

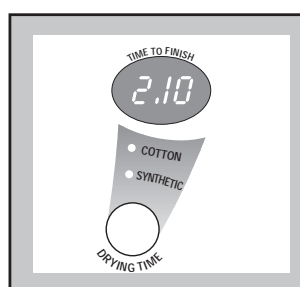

4. Start the programme

Depress the START/PAUSE button to start the programme.

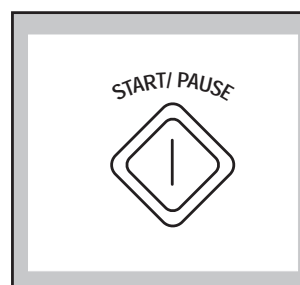

5. At the end of the programme

The machine stops automatically and three flashing zeros are displayed.

Depress the ON/OFF button again to switch the machine off. Remove the laundry.

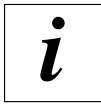

Washing and Drying Hints

Do **NOT** overload the machine. Weigh the laundry the first few times you use the appliance.

The average weights of the most common items are listed below as a guide:

1000g = 1 kg

Sheet	700-1000 g
Pillow case	100-200 g
Tablecloth	400-500 g
Serviette	50-100 g
Tea towel	70-120 g
Linen hand towel	100-150 g
Towelling hand towel	150-250 g
Towelling bath towel	700-1000 g
Bath robe	1000-1500 g
Man's shirt	200-300 g
Apron	150-200 g

- Load the laundry loosely alternating large items with small ones.
- Sort the laundry according to the type of fabric, colour-fastness and how dirty it is.
- Avoid washing unhemmed or torn items as they may unravel.
- Before washing, empty all pockets of small objects which may have been left inside (coins, keys, screws etc). as these could damage the drain pump.
- When washing curtains, remove the hooks.
- Close poppers and zips and fasten loose buttons.
- It is essential to wash new coloured items separately when washing for the first time.
- When washing fabrics requiring different wash temperatures together, always select the lowest temperature.
- White items should not be washed with coloured items.
- Very small items (handkerchiefs, ribbons, socks etc) should be washed in a washing bag or a pillow case.
- Use a good quality detergent suitable for automatic washing machines.
- Use the correct quantities of detergent.
- For wool, use gentle detergent only in small quantities.
- Bleach is very corrosive; it should be used with care and kept out of reach of children.
- Some stains such as fruit, wine, grass, rust etc. are difficult to remove and should be treated before washing with specific products, which can be found in most household shops. In some cases it may help to soak the stain before washing with a special pre-soak product or biological detergent.
- If you have used the machine to wash, rinse or spin only non-colour fast garments, there may be dye left in the sump. To ensure any subsequent wash is not contaminated with the dye, select and carry out a rinse and spin programme, without any garments, to ensure that any dye is removed from the sump.
- Do not leave the damp laundry load in a heap too long before drying.
- Avoid drying dark clothes with light coloured fluffy items such as towels as these can attract the fluff.
- If you overdry the laundry, besides wasting energy, any subsequent ironing may become more difficult because the fabric could be heavily crumpled.
- Remove the laundry when the appliance has finished drying.
- To avoid a static charge when drying is completed, use either a fabric softener when you are washing the laundry or a fabric conditioner specifically for tumble dryers.
- Particularly delicate items such as synthetic curtains, woollen and silk, garments with metal inserts, nylon stockings, bulky garments such as anoraks, bedcovers, quilts, sleeping bags and duvets must not be machine dried.
- Garments padded with foam-rubber or materials similar to foam-rubber must not be machine dried; they represent a fire hazard.
- Also, fabrics containing residues of setting lotions or hair sprays, nail solvents or similar solutions must not be machine dried in order to avoid the formation of harmful vapours.
- For drying, follow the indications given on the manufacturer's labels.
 - Drying at high temperature
 - Drying at reduced temperature
 - Do not tumble dry

Important:

As a dryer, the machine works on the condensation principle.

Therefore, the water tap must be open and the drain hose must drain water into a sink or into the drain pipe, even during the drying cycle.

Which detergent?...

To ensure you obtain the best wash results from your appliance, it is important to use the right detergent in your everyday wash, and only detergents recommended for use in automatic machines.

To maintain the appearance of your clothes and household textiles and to make them last longer you should use different types of detergent for different washes, whether for whites, colours or delicates.

WHITES

We recommend the Ariel product range which is biological and designed to provide excellent cleaning and stain removal even at low temperatures.



NON BIOLOGICAL

If you prefer to use a non biological detergent, which does not contain enzymes we recommend Fairy. Fairy provides good cleaning and stain removal.



COLOURED

For coloured items you should use a detergent which is designed to clean while maintaining the original colour. Ariel Color does not contain bleach and therefore helps to preserve colours.



DELICATE ITEMS

When washing delicates such as woollens, you should use a product which is specially designed to care for fine fabrics.

Dreft Automatic is suitable for woollens and other delicates.



LAUNDRY BLEACH

For additional stain removal you may wish to use a product such as Ace Gentle Bleach which is used in addition to your chosen detergent. Ace is suitable for all washable fabrics including silks, woollens and coloureds.



And in which form?

Not only are there different types of detergent, but they are also available in different forms. Whether you chose a powder or liquid in traditional or compact form is to own personal choice.

TRADITIONAL POWDERS

Pour the powder directly into the dispenser drawer. Do not sprinkle powder onto clothes in the machine drum.

TRADITIONAL LIQUIDS

Liquid can be placed in the main wash compartment of the detergent drawer marked with the symbol , start the machine immediately upon placing the detergent in the dispenser drawer.

Alternatively the detergent is measured into the specially designed dosing device* which should be placed on top of the laundry, and at the back of the machine drum.

COMPACT POWDERS AND LIQUIDS

Compact detergents (or concentrates as they are also known) are available in liquid or powder form, and generally require a smaller dosage. Follow the manufacturer's instructions to ensure the most economical usage. Pour the detergent directly into the dispenser drawer, or alternatively measure the detergent into the specially designed dosing device* which should be placed on top of the laundry, and at the back of the machine drum.

* **If you use a dosing device in a washer dryer, please ensure the dosing device/ball is removed before carrying out a drying programme.**

FABRIC CONDITIONERS

These are ideal for improving 'softness', and also reduce static cling on synthetics and make ironing easier. They are available in two types:

For example Lenor liquid fabric softener, for use in the **washing machine/washer dryer**. The liquid fabric softener should be poured into the compartment marked with the symbol . Follow the manufacturer's dosage instructions and never exceed the MAX level.



Bounce conditioning sheets for use in a **tumble dryer**. We recommend the conditioning sheets are pinned (using a safety pin) to an article of laundry and placed in the tumble dryer.



i Preparing the drying cycle

As a dryer, the machine works on the condensation principle.

Therefore, **the water tap must be open and the drain hose must drain water into a sink or into the drain pipe, even during the drying cycle.**

Load

Sort of laundry	max. load (dry weight)
Linen and cottons	2.5 kg
Synthetics	2 kg

Warning:

Loads of washed laundry exceeding these values must be divided before being dried, otherwise poor results will be obtained.

Garments not suitable for drying

- Particularly delicate items such as synthetic curtains, woollen and silk, garments with metal inserts, nylon stockings, bulky garments such as anoraks, bedcovers, quilts, sleeping bags and duvets must not be machine dried.
- Garments padded with foam-rubber or materials similar to foam-rubber must not be machine dried; they represent a fire hazard.
- Also, fabrics containing residues of setting lotions or hair sprays, nail solvents or similar solutions must not be machine dried in order to avoid the formation of harmful vapours.

Drying symbols on garment labels

Always look at the garment label to check whether garments can be machine dried.

The following symbols refer to drying:



Machine drying is usually possible



Normal drying (normal temperature)



Gentle drying (reduced temperature)



Do not machine dry

Garments marked with the symbol  should not be machine dried.

Duration of the drying cycle

The drying time can vary according to

- the final spin speed,
- the required degree of drying,
- the type of laundry
- the size of load.

The usual drying times for the time controlled drying are indicated in the programme chart. As you become more familiar with the appliance, you will discover the drying times that best suit your needs according to the various type of fabric. It is a good idea to make a note of these times.

The following are the degrees of final drying which can be selected with the automatic drying:

■ Cotton

- Extra dry
- Store dry
- Iron dry

■ Synthetics

- Store dry

To finish off drying or to dry small loads you can choose a time controlled drying.

When selecting the drying time you should remember that it includes a 10 minute cooling phase.

Additional drying

Should the laundry still be too wet at the end of the programme, set another short drying time.

Warning! To prevent the formation of creases or shrinking of fabrics, avoid excessive drying.

















Fibre residue

After drying fluffy fabrics, such as new towels, it is advisable to perform the rinse programme to be sure that any residue that may remain in the tub is completely removed and does not stick to garments dried afterwards.

After each drying cycle the filter should be checked and cleaned if necessary.

Wash Care Symbols

Wash care labels inside garments recommend how to launder your clothes with the best results. The care labelling code is in line with care labelling used in the rest of Europe. The symbols used make it easy to select the correct programme on your washing machine.



WASHING SYMBOL	WASH ACTION	FABRIC
	Normal (Maximum)	White Cotton or Linen without Special Finishes
	Normal (Maximum)	Cotton, Linen or Viscose without Special Finishes Colourfast at 60°C.
	Reduced (Medium)	Nylon, Polyester/Cotton, Viscose with Special Finishes, Cotton/Acrylic Mix.
	Normal (Maximum)	Cotton, Linen or Viscose Colourfast at 40°C but not 60°C.
	Reduced (Medium)	Acrylics, Acetate, Triacetate, Wool mixes, Polyester/wool blends.
	Much Reduced (Minimum)	Wool, wool mixtures, Silks
	Hand wash only	Do not machine wash
BLEACHING		
	Chlorine bleach may be used	
IRONING		
	Hot iron	Cotton, Linen, Viscose
	Warm iron	Polyester mixtures, Wool
	Cool iron	Acrylic, Nylon, Polyester
DRY CLEANING		
	May be dry cleaned. Other letters and/or a bar beneath the circle will indicate the required process to the dry cleaner.	
TUMBLE DRYING		
	May be tumble dried	
	with high heat setting	
	with low heat setting	
	A cross through any symbol means «DO NOT»	

Important Notes

For best results, always use the dispenser drawer for dispensing detergents and liquid additives. Once the dispenser has been filled, close it by pushing it in gently. This is particularly important if you are using

fabric conditioner to avoid the conditioner entering the machine prematurely. When using liquid detergent and a prewash programme, place the detergent into the correct compartment in the dispenser drawer, after the prewash has finished.

Washing Programmes

Fabrics	Temperature	Wash load	Additional functions	Max. load	Progr. time mins
White cotton	95°-60°	White cotton, for example normally soiled work garments, sheets, household linen, underwear, towels.	PREWASH QUICK WASH SPIN SPEED RINSE HOLD	5 kg	160
White cotton ECONOMY	95° (60°)	White cotton economy, for example lightly soiled sheets and household linen.	SPIN SPEED RINSE HOLD	5 kg	160
Coloured cotton(*)	60°-40°-30°	Coloured cotton or linen fabric, shirts, underwear, towels.	PREWASH QUICK WASH SPIN SPEED RINSE HOLD	5 kg	130
Coloured cotton ECONOMY	60° (40°)	Coloured garments economy, for example delicate coloureds, men's shirts, blouses, underwear.	SPIN SPEED RINSE HOLD	5 kg	130
Synthetic	60°-40°-30°	Synthetic fabrics, underwear, coloured garments, non-shrink shirts, blouses.	PREWASH QUICK WASH SPIN SPEED RINSE HOLD	2 kg	90
Synthetic(**) ECONOMY	60° (40°)	Synthetics economy, for example lightly soiled synthetic garments, shirts, blouses. Mixed fabrics.	SPIN SPEED RINSE HOLD	2 kg	90
Delicate	40°-30°- COLD	Delicate fabrics, for example curtains.	PREWASH QUICK WASH RINSE HOLD	2 kg	60
Wool 	40°-30°- COLD	Specially tested programme for wool garments bearing the "Pure new wool, non-shrink, machine washable" label.	SPIN SPEED RINSE HOLD	1 kg	60
Wool + Quick Wash (***)	40°-30°- COLD	Special programme for handwash garments  .	SPIN SPEED RINSE HOLD	1 kg	60

(*) This programme at 60°C is the reference programme for the Energy label according to EEC Directive 92/75.

(**) Use this programme for mixed fabrics with the label .

(***) This programme has an extremely delicate wash action suitable for machine washing garments with the hand wash symbol .

Special Programmes

Programme	Type of laundry	Additional functions	Max. load	Progr. time mins
Soak	Heavily soiled fabrics, except wool.		5 kg	28
Mini	Lightly soiled fabrics, except wool.		2 kg	30
Rinses	This programme can be used for rinsing hand washed garments.	SPIN SPEED RINSE HOLD EXTRA RINSE	5 kg	20
Drain	For emptying out the last rinse water in programmes with the Rinse Hold option.		5 kg	5
Spin	Separate spin for all fabrics.	SPIN SPEED	5 kg	5

Detergent quantities

As the Jetsystem is flexible and adjusts water intake according to wash load size it is not possible to give you exact recommendations as to the amount of detergent that should be used for any one wash.

Therefore we recommend that you use approximately 1/3 less than the detergent manufacturer recommends on the packet or bottle, making the appropriate allowances for soft or hard water, and light or heavy soilage of clothes. If you have judged the amount correctly you should expect to see a soft sudsy liquid during the wash. It is not necessary to have a head of lather on the water.

Drying Programmes

Cotton: max. load 2.5 kg

Degree of drying	Type of laundry	Drying time in minutes to be selected for laundry spun at	
		1500 rpm	1200 rpm
Extra dry	Towelling materials (bathrobes, bath towels, etc.)	75-85	80-90
Store dry (*)	Items which you want to put away without ironing: terry towels, knitwear, babywear.	65-75	70-80
Iron Dry	For items which need ironing: sheets, tablecloths, table napkins, etc.	45-55	50-60

Synthetics: max. load 2 kg

Degree of drying	Type of laundry	Drying time in minutes to be selected for laundry spun at	
		900 rpm	700 rpm
Store dry	Synthetics or mixed fabrics which do not require ironing: shirts, blouses, outerwear.	85-95	90-100

(*) This programme performed with time controlled drying is the reference programme for the Energy label, according to EEC Directive 92/75.

Maintenance and Cleaning

Before any maintenance or cleaning is carried out you must **DISCONNECT** the appliance from the electricity supply.

Descaling

The water we normally use contains lime. It is a good idea to periodically use a water softening powder in the machine. Do this separately from any laundry washing, and according to the softening powder manufacturer's instructions. This will help to prevent the formation of lime deposits.

After each wash

Leave the door open for a while. This helps to prevent mould and stagnant smells forming inside the appliance. Keeping the door open after a wash will also help to preserve the door seal.

External cleaning

Clean the exterior cabinet of the appliance with soap and water only, and then dry thoroughly.

Cleaning the dispenser drawer

From time to time the washing powder and additive dispenser drawer should be cleaned.

Remove the drawer by pressing the catch downwards and by pulling it out. Flush it out under a tap, to remove any traces of accumulated powder.

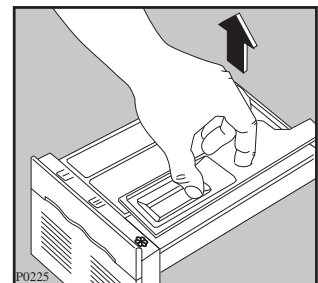
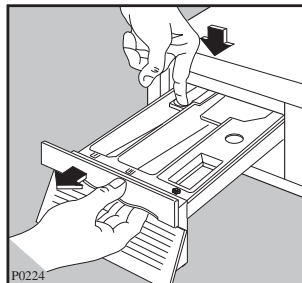

Cleaning the drawer recess

Having removed the drawer, use a small brush to clean the recess, ensuring that all washing powder residue is removed from the upper and lower part of the recess.

Replace the drawer and run the rinse programme for a few minutes without any clothes in the drum.

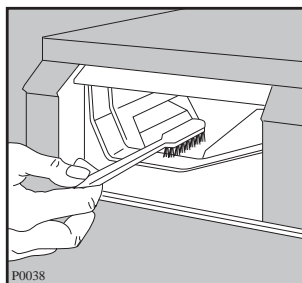

Cleaning the filter

The water drain filter

A clean filter is important for the correct functioning of the machine, and should therefore be cleaned after every washing programme.

Open the filter door and place a container underneath to catch any spillage. If the filter is blocked and the machine is unable to drain you will need to drain the water manually from the machine at this stage. To do this, unhook the drain hose from the standpipe or sink and hold the end of the hose over a bowl on the floor. The water should drain by gravity into the bowl. When the bowl is full, hook the hose back up and empty the bowl. Repeat the procedure until water stops flowing out.

Unscrew and remove the filter.

Clean carefully under a fast running tap.

Warning

When the appliance is in use and depending on the programme selected there can be hot water in the filter. Never remove the filter during a wash cycle, always wait until the appliance has finished the cycle, and is empty. When replacing the filter, ensure it is securely retightened so as to stop leaks and young children being able to remove it.

The water inlet filter

If your water is very hard or contains traces of lime deposit, the water inlet filter may become clogged.

It is therefore a good idea to clean it from time to time.

Turn off the water tap. Unscrew the water inlet hose. Remove and clean the filter using a hard bristle brush. Replace the filter and tighten up the inlet hose.

The dangers of freezing

If the machine is exposed to temperatures below 0°C, certain precautions should be taken.

- Turn off the water tap.
- Unscrew the inlet hose.
- Unhook the drain hose from the rear support and position the end of this hose and that of the inlet hose in a bowl. Run the draining programme.
- Disconnect the appliance.
- Screw the inlet hose and reposition the drain hose.
- When you intend to start the machine up again, make sure that the room temperature is above 0°C.

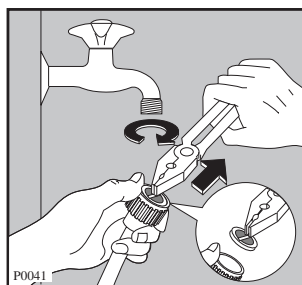
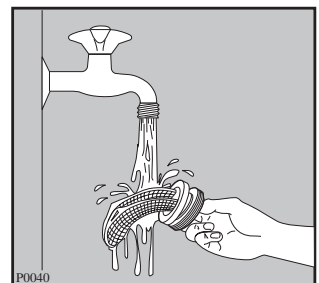
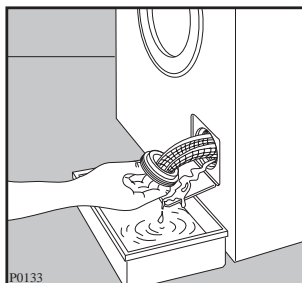
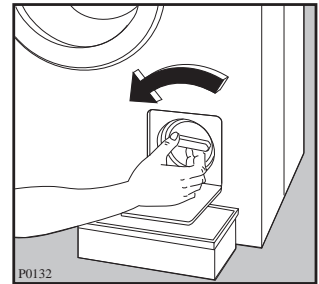
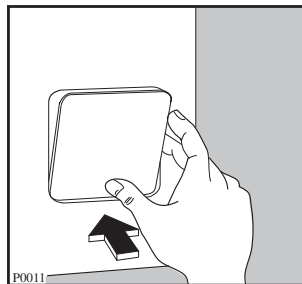

Something Not Working

In the event of operating problems, you are advised to read the following chart carefully before calling the service centre.

The following alarm codes may be displayed:

- **E00:** problem with the water supply
- **E10:** problem with water draining
- **E20:** door open

Once the problem has been eliminated, press the START/PAUSE button to restart the programme.

IMPORTANT: if you call out an engineer to a fault listed below, or to repair a fault caused by incorrect use or installation, a charge will be made even if the appliance is under guarantee.

Symptom	Possible causes
The machine does not start	<ul style="list-style-type: none"> ■ The door has not been closed. (E20) ■ The plug is not properly inserted in the power socket. ■ There is no current at the socket ■ The main fuse or the fuse in the plug has blown. ■ The START/PAUSE button has not been pressed. ■ The DELAY START option has been selected.
The machine does not fill	<ul style="list-style-type: none"> ■ Ensure the water tap is open. (E00) ■ The filter in the inlet hose is blocked. (E00) ■ The inlet hose may be squashed or kinked. (E00) ■ The door has not been closed. (E20)
The machine fills then empties immediately	<ul style="list-style-type: none"> ■ The end of the drain hose is too low. ■ The end of the drain hose is submerged in water. ■ There is no vent in the end of the drain hose.
The machine does not empty and/or does not spin	<ul style="list-style-type: none"> ■ The drain hose may be squashed or kinked. (E10) ■ The RINSE HOLD option has been selected. ■ The drain filter may be blocked. (E10) ■ The drain hose extension is not correct. Follow the instructions for connecting to the waste. ■ The drainage system pipes are blocked.
There is water on the floor	<ul style="list-style-type: none"> ■ Too much detergent or unsuitable detergent has been used (creates too much foam). ■ Check whether there are any leaks from one of the inlet hose fittings. It is not always easy to see this as the water runs down the hose; check to see if it is damp. ■ The drain hose may be damaged or not securely positioned. ■ The detergent dispenser drawer or recess is clogged. ■ The drainage system pipes are blocked.
Unsatisfactory washing results	<ul style="list-style-type: none"> ■ Too little detergent or unsuitable detergent has been used. An insufficient amount of detergent leaves the laundry looking grey and causes lime scale to form. ■ Stubborn stains have not been treated prior to washing. ■ The correct temperature to suit the wash programme has not been selected. ■ Too much laundry has been placed in the drum.
The machine vibrates when spinning	<ul style="list-style-type: none"> ■ The internal packing has not been removed. ■ The machine is in contact with the wall or furniture. ■ The machine is not level. ■ The washing load is badly distributed in the drum. ■ Maybe there is very little laundry in the drum.

Symptom	Possible causes
The door will not open	<ul style="list-style-type: none"> ■ The programme is still running. ■ The door lock has not yet released (door pilot light on). ■ The water level in the drum is too high or the machine is heating.
Spinning starts late or the machine does not spin	<ul style="list-style-type: none"> ■ The electronic unbalance detection device has cut in because the laundry is not evenly distributed in the drum. The laundry is redistributed by reverse rotation of the drum. This may happen several times before the unbalance disappears and normal spinning can resume eventually at a lower speed, if the wash load is not perfectly distributed in the drum. If, after 15 minutes, the laundry is still not evenly distributed in the drum, the machine will not spin. In this case, redistribute the load manually and reselect the spin programme.
The machine makes an unusual noise	<ul style="list-style-type: none"> ■ The machine is fitted with a type of motor which makes an unusual noise compared with other traditional motors. This new motor ensures a softer start and more even distribution of the laundry in the drum when spinning, as well as increased stability of the machine.
No water is visible in the drum	<ul style="list-style-type: none"> ■ Machines based on modern technology operate very economically using very little water without affecting performance.
The machine will not dry or the laundry is not dry enough	<ul style="list-style-type: none"> ■ The water tap is closed. (E00) ■ The drain filter is clogged. (E10) ■ The correct drying programme or time has not been selected. ■ There is too much laundry in the appliance. ■ The laundry has not been spun enough before drying.

If after the above checks, there is still a fault, call your local Zanussi Service Force Centre.

Service & Spare Parts

If you require an engineer or wish to purchase spare parts contact your local Zanussi Service Force Centre by telephoning:

0870 5 929929

Your telephone call will be routed to the Service Centre covering your post code area.

Further information can be found in the accompanying customer care booklet and also in your telephone directory under "Z".

When you call the Service Force Centre please make sure you give the model and serial number of the appliance.

This information can be found on the rating plate (see picture) or on the guarantee card.

In-guarantee customers should ensure that the above checks have been made as the engineer will make a charge if the fault is not a mechanical or electrical breakdown. Please note that proof of purchase is required for any in-guarantee service calls.

Customer Care

For general enquiries concerning your Zanussi appliance or for further information on Zanussi products, please contact our Customer Care Department by letter or telephone as follows:

Customer Care Department

Zanussi

Zanussi House

Hambridge Road

Newbury

Berkshire

RG14 5EP

Tel 01635 521313

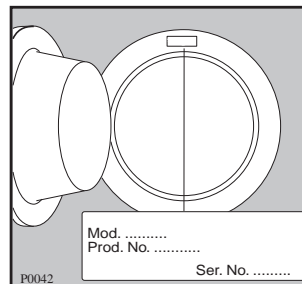

Peace of Mind for Twelve Months

Standard guarantee conditions

We, Zanussi Limited undertake that if, within 12 months of the date of the purchase, this Zanussi appliance or any part thereof is proved to be defective by reason only of faulty workmanship or materials, we will, at our option, repair or replace the same **FREE OF ANY CHARGE** for labour, materials or carriage on condition that:

- The appliance has been correctly installed and used only on the electricity supply stated on the rating plate.
- The appliance has been used for normal domestic purposes only, and in accordance with the manufacturer's instructions.
- The appliance has not been serviced, maintained, repaired, taken apart or tampered with, by any person not authorised by us.

All service work under this guarantee must be undertaken by a Zanussi Service Force Centre.

Any appliance or defective part replaced shall become the Company's property.

This guarantee is in addition to your statutory and other legal rights.

Home visits are made between **8.30am** and **5.30pm** Monday to Friday. Visits may be available outside these hours in which case a **premium** will be charged.

Exclusions

This guarantee does not cover:

- Damage or calls resulting from transportation, improper use or neglect, the replacement of any light bulbs or removable parts of glass or plastic.
- Costs incurred for calls to put right an appliance which is improperly installed or calls to appliances outside the United Kingdom.
- Appliances found to be in use within a commercial environment, plus those which are subject to rental agreements.
- Products of Zanussi manufacture which are **NOT** marketed by Zanussi Ltd.

European guarantee





If you should move to another country within Europe then your guarantee moves with you to your new home subject to the following qualifications:

- The guarantee starts from the date you first purchased your product.
- The guarantee is for the same period and to the same extent for labour and parts as exists in the new country of use for this brand or range of products.
- The guarantee relates to you and cannot be transferred to another user.
- Your new home is within the European Community (EC) or European Free Trade Area.
- The product is installed and used in accordance with our instructions and is only used domestically, i.e. a normal household.
- The product is installed taking into account regulations in your new country.

Before you move please contact your nearest Customer Care Centre, listed below, to give them details of your new home. They will then ensure that the local Service Organisation is aware of your move and able to look after you and your appliances.

France	Senlis	+33 (0)344 62 29 99
Germany	Nurnberg	+49 (0)911 323 2600
Italy	Pordenone	+39 (0)1678 47053
Sweden	Stockholm	+46 (0)8 738 79 50
UK	Newbury	+44 (0)1635 521313

Installation Instructions

-  It is dangerous to alter the specifications or attempt to modify this product in any way.
-  Care must be taken to ensure that the appliance does not stand on the electrical supply cable.
-  Any electrical work required to install this appliance should be carried out by a qualified electrician or competent person.
-  Any plumbing work required to install this appliance should be carried out by a qualified plumber or competent person.

Technical Specifications

DIMENSIONS	Height Width Depth	85 cm (33.5") 60 cm (23.6") 60 cm (23.6")
POWER SUPPLY VOLTAGE TOTAL POWER ABSORBED		220-240 V/50 Hz 2050 W (10A)
WATER PRESSURE	Minimum Maximum	0.48 bar (4.8 N/cm ²) 7.6 bar (76 N/cm ²)
MAXIMUM RECOMMENDED LOAD	Washing Cotton, linen Synthetics Delicate fabrics Wool Drying Cotton, linen Synthetics	5 kg (11 lbs) 2 kg (4.5 lbs) 2 kg (4.5 lbs) 1 kg (2.2 lbs) 2.5 kg (5.5 lbs) 2 kg (4.5 lbs)
SPIN SPEED	Maximum	1500 rpm



This appliance complies with the following E.E.C. Directives:
 - 73/23 EEC of 19.2.73 (Low Voltage Directive) and subsequent modifications;
 - 89/336 EEC of 3.5.89 (Electromagnetic Compatibility Directive) and subsequent modifications.

Unpacking

 All transit bolts and packing must be removed before using the appliance.

You are advised to keep all the packaging for re-use in case the machine is to be transported again.

Using a spanner unscrew and remove the rear right bolt. Lay the machine gently on its back, making sure that the hoses are not squashed.

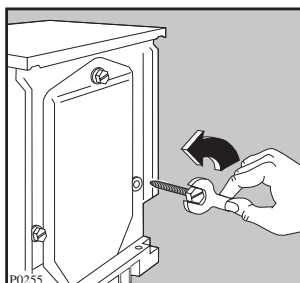

Remove the polystyrene block from the bottom of the machine.

Carefully slide out the right polythene bag (1).

Repeat the operation for the left polythene bag (2).

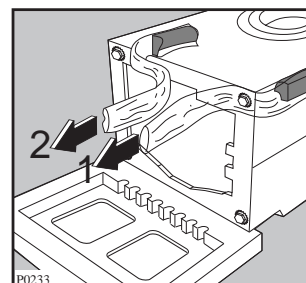
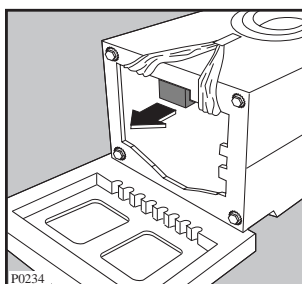

Remove the polystyrene base.

Set the machine upright and remove the two remaining bolts from the back.

Pull out the three plastic spacers from the holes into which the bolts were fitted.

Plug the open holes with the plugs which you will find in the plastic bag containing the instruction booklet.

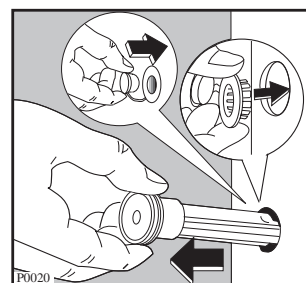
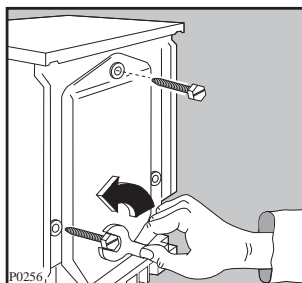

Positioning

Install the machine on a flat hard floor.

Make sure that air circulation around the machine is not impeded by carpets, rugs etc. Check that the machine does not touch the wall or other kitchen units.

Never place cardboard, wood or similar materials under the machine to compensate for any unevenness in the floor.

Your new machine has been designed to be permanently plumbed in to your home's water supply and drainage system. However, if this is not possible, it may be connected to a suitable existing tap with the drain hose discharging into a sink.

Water inlet

Before connecting the hose be sure to fit the mesh filter «A» supplied as per diagram.

Installation should comply with local water authority and building regulations' requirements.

Set the hose correctly by loosening the ring nut. After positioning the inlet hose, be sure to tighten the ring nut again to prevent leaks.

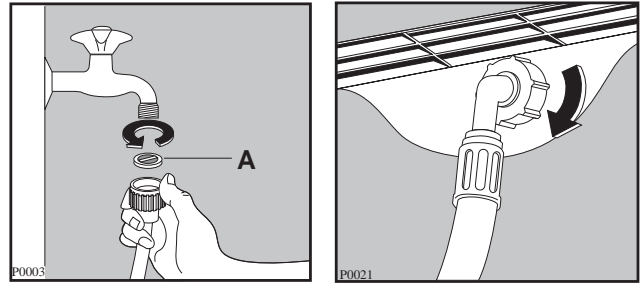

Water drainage

This appliance is designed to be permanently plumbed into your home's water supply and drainage system.

The appliance drain hose should hook into a standpipe, the hook in the drain hose is formed using the plastic "U-Piece" supplied.

The standpipe should have an internal diameter of approximately 38mm (see diagram) thus ensuring there is an air break between the drain hose and standpipe.

When discharging into a standpipe ensure that the top of the curve in the hose end is no more than 90cm (35.4") and no less than 60cm (23.6") above floor level. The upright standpipe should have a minimum length of 30cm (12") from the bottom of the elbow to the top of the pipe (see diagram).

Make sure that it is designed in such a way, that the end of the drain hose cannot be covered with water.

The drain hose may be extended to a maximum of 4 metres. An additional drain hose and joining piece is available from your local Service Force Centre. The joining piece must have an internal diameter of 18mm.

If you intend the drain hose to empty into a sink, make sure that the sink is empty and the plug hole is not blocked. Use the plastic "U-Piece" supplied.

Important

Before connecting up the machine to new pipework or to pipework that has not been used for some time, run off a reasonable amount of water to flush out any debris that may have collected in the pipes.

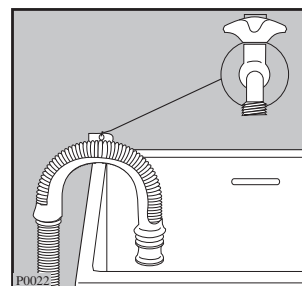
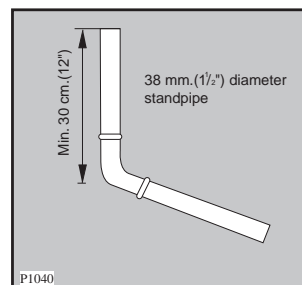
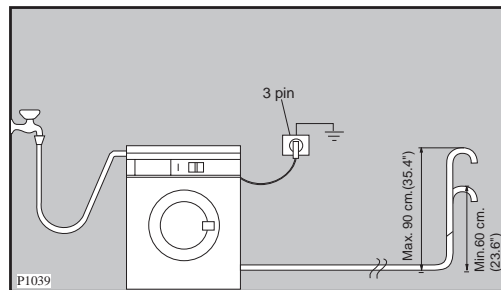

Levelling

Level the washing machine by raising or lowering the feet. The feet may be tight to adjust as they incorporate a self locking nut, but the machine **MUST** be level.

Any necessary adjustment can be made with a spanner. Accurate levelling prevents vibration, noise and displacement of the machine during operation.

Some vibration is inevitable, especially if mounted on a wooden floor.

Sprung wooden floors are particularly susceptible to vibration. For advice, consult a builder. If possible, always place the machine on a solid floor.

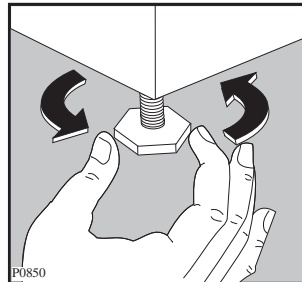

Special conditions

If the floor is carpeted or covered with crumbly or soft material, insert a rigid support base under the feet to prevent noise, vibration or displacement. The base should protrude a few centimetres beyond the edges of the machine.



Warning

The machine should **NOT** be placed on deep pile carpeting.

Note

Please ensure that when the appliance is installed it is easily accessible for the engineer in the event of a breakdown.

In the interest of the environment

Washing machines and dishwashers should be connected to the **FOUL** drainage system, the water will then be taken to a sewage works for treatment before being discharged safely into a river.

It is essential that these appliances are not connected to the surface water drainage system as this water is discharged directly into a river or stream and may cause pollution.

If you require any further advice please contact your local authority drainage department.

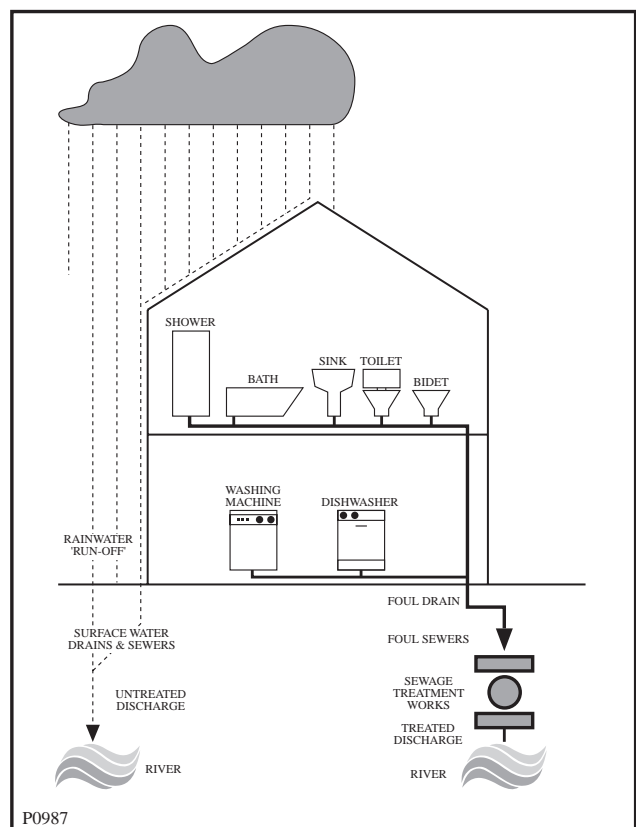

Electrical connection

Any electrical work required to install this appliance should be carried out by a qualified electrician or competent person.

WARNING: THIS APPLIANCE MUST BE EARTHED.



The manufacturer declines any liability should this safety measure not be observed.

Before switching on, make sure the electricity supply voltage is the same as that indicated on the appliance's rating plate. The rating plate is located at the top of the rim of the open door.

The appliance is supplied with a 13amp plug fitted. In the event of having to change the fuse in the plug supplied, a 13amp ASTA approved (BS1362) fuse must be used.

Should the plug need to be replaced for any reason, proceed as described below.

The wires in the mains lead are coloured in accordance with the following code:

- | | |
|------------------|-----------|
| Green and Yellow | - Earth |
| Blue | - Neutral |
| Brown | - Live |

The wire coloured green and yellow must be connected to the terminal marked with the letter «E» or by the earth symbol \perp or coloured green and yellow.

The wire coloured blue must be connected to the terminal «N» or coloured black.

The wire coloured brown must be connected to the terminal marked «L» or coloured red.

Upon completion there must be no cut, or stray strands of wire present and the cord clamp must be secure over the outer sheath.

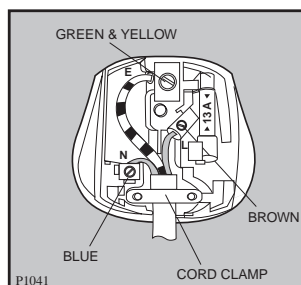
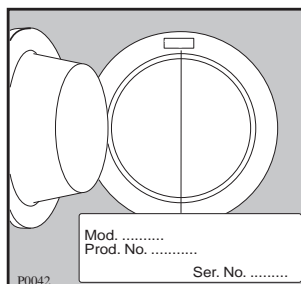

WARNING:



A cut off plug inserted into a 13 amp socket is a serious safety (shock) hazard.

Ensure that the cut off plug is disposed of safely.

Permanent connection

In the case of permanent connection it is necessary that you install a double pole switch between the appliance and the electricity supply (mains), with a minimum gap of 3mm between the switch contacts and of a type suitable for the required load in compliance with the current electrical regulations.

The switch must not break the yellow and green earth cable at any point.

